

How To Use a **Rapid Diagnostic Test (RDT)**



A guide for training at a village and clinic level

*Modified for training in the use of the **First Response Malaria HRP2 (II3FRC30) Test**
for falciparum malaria*

Prepared on August 9, 2010. V1.6



Produced by the Foundation for Innovative New Diagnostics (FIND) from generic material developed jointly by the World Health Organization (WHO), United States Agency for International Development (USAID), University Research Co., LLC (URC), Special Programme for Research and Training in Tropical Diseases (TDR), Malaria Consortium and Zambia National Malaria Control Centre.

First Response Malaria HRP2

Support for developing this training manual was provided by the United States Agency for International Development (USAID), the Special Programme for Research and Training in Tropical Diseases (TDR) and the Australian Agency for International Development (AusAID).

The mention of specific companies or of certain manufacturer's products does not imply that they are endorsed or recommended by the World Health Organization in preference to others of a similar nature that are not mentioned.

Errors and omissions excepted, the names of proprietary products are distinguished by initial capital letters.

The World Health Organization does not warrant that the information contained in this publication is complete and correct and shall not be liable for any damages incurred as a result of its use.

Suggested citation:

How to use a rapid diagnostic test (RDT): A guide for training at a village and clinic level (Modified for training in the use of the First Response Malaria HRP2 [113FRC30] Test for falciparum malaria). 2010. The USAID Quality Assurance Project (QAP), University Research Co., LLC, and the World Health Organization (WHO), Bethesda, MD, and Geneva.

NOTE ON MODIFYING THIS MANUAL TO SUIT YOUR COUNTRY'S MALARIA CONTROL POLICIES

This manual and the accompanying material are designed to train health workers in the safe and accurate use of malaria rapid diagnostic tests (RDTs). But correct RDT use is only one part of managing malaria. Health workers also need to know what steps to take after diagnosis, whether the patient is RDT-positive or negative for malaria. National policies for treating malaria differ between countries. Causes of fever also differ. For that reason, this manual addresses only diagnosis, not treatment. Health workers who complete this training on RDT use will also need separate training on your country's national policy for anti-malarial drug use and for appropriate management of RDT-negative febrile cases.

RDT designs also differ. These instructions and the accompanying job aid were designed using an RDT cassette specific for detection of falciparum malaria. If your country is using a different RDT, you may need to modify the training and job aid to fit the brand and type of RDT you are using. Particular sections of the training that might need modification include:

- Section 1.4.1 on possible false positive results;
- Sections 2.6.3, 2.10, 2.11, and 2.13 on where to add blood and assay diluent;
- Section 2.16 and Section 5 on interpreting test results.

The job aid may also need modification to fit the design, preparation and target species of the RDT in use before participants can correctly complete sections 4 and 5 of the training.

WHO can assist with these modifications.

(Contact national WHO office or mal-rdt@wpro.who.int)

Table of Contents

Glossary of acronyms	iv
Acknowledgements.....	v
Introduction to trainers on the use of this manual	1
Purpose.....	1
What this manual contains	1
How to use the manual	2
Why use RDTs	2
Why are job aids and training necessary?	3
Materials and supplies needed	4
Section 1 Introduction (20 minutes).....	5
Section 2 How to use an RDT (60 minutes).....	8
Section 3 How to take a finger-prick blood sample (30 minutes)	17
Section 4 Perform a malaria rapid diagnostic test (60 minutes).....	19
Section 5 Read test results (45 minutes).....	22
Frequently asked questions	24
Other useful reference materials.....	26
Job aid	27
Sample test #1	28
Sample test #2	29
Sample test #3	30
Answer keys for sample tests	31
RDT interpretation chart	33
Blank answer sheets for sample tests	34

Glossary of acronyms

ACT	Artemisinin combination therapy
AFRO.....	WHO – Regional Office for Africa
ALRI.....	Acute lower respiratory infection
AQ	Amodiaquine
CHW	Community health worker
CQ	Chloroquine
HRP2.....	Histidine-rich protein 2 (<i>a malaria parasite antigen</i>)
MOH	Ministry of Health
QAP	The USAID Quality Assurance Project
pLDH	Plasmodium lactate dehydrogenase (<i>a malaria parasite antigen</i>)
RDT	Rapid diagnostic test
SP	Sulfadoxine-pyrimethamine
URC.....	University Research Co., LLC
USAID.....	United States Agency for International Development
WHO.....	World Health Organization
WPRO	WHO Regional Office for the Western Pacific

Acknowledgements

The original manual of 'How to use a Rapid Diagnostic Test (RDT) – a guide for training at a village and clinic level' (from which this specific manual was adapted) was developed by USAID (under the Quality Assurance Project), University Research Co., LLC (URC), WHO/AFRO and WHO/ WPRO offices based on research carried out in Zambia during 2006. URC developed the illustrations for both the manual and the job aid.

We further wish to acknowledge the Zambia Ministry of Health, the Zambia National Malaria Control Centre, the District Health Management Teams (DHMT) and health workers of Luangwa, Chongwe, Chibombo and Livingstone districts, Zambia, for their work on which the original manual was based. Special thanks to officers of NMCC of Zambia, who served as both national project coordinators and model trainers during the research that led to development of this manual. The training curriculum described here is based on the authors' observations of the officer-in-charge of trainings in NMCC, Zambia.

We are grateful to the WHO malaria representative in Zambia, and colleagues of Boston University for their help in coordinating the different aspects of the research and development. Thanks also for the reviewers of the manual's content and their insightful suggestions for improvement. We appreciate the inputs from the USAID Mission in Lusaka and the study's observers from the University of Zambia and the Ministry of Health during the development of the original manual.

Funding for the development of this manual was provided by the Bill and Melinda Gates Foundation through the Foundation for Innovative New Diagnostics (FIND), the United States Agency for International Development (USAID) and the Australian Agency for International Development (AusAID). Development of the original generic manual was a joint effort of the USAID Quality Assurance Project (QAP), the Special Programme for Research and Training in Tropical Diseases (TDR), University Research Co., LLC, the WHO – Regional Office for the Western Pacific (WPRO), the WHO – Regional Office for Africa (AFRO), and the Zambian Ministry of Health. This version of the manual was adapted by WHO/WPRO and URC with Third Wave Creatives.

Introduction to trainers on the use of this manual

Purpose

The purpose of this manual is to train community health workers (CHWs) to use malaria rapid diagnostic tests (RDTs) safely and effectively. The manual is written for professional health workers who will be teaching volunteer CHWs how to use RDTs. The original manual from which this specific manual was adopted was developed and tested in Zambia with the Zambian National Malaria Control Centre and Zambian CHWs. Although the training is mainly intended for CHWs, it may also be useful to professional health workers new to using RDTs.

This manual should be used with the accompanying job aid. The job aid is a set of step-by-step instructions about how to use an RDT. It contains both words and pictures. You will find a small version of the job aid at the end of this manual.

Larger copies are available from www.wpro.who.int/sites/rdt or from http://www.finddiagnostics.org/programs/malaria/find_activities/rdt-job-aids/. At the end of the training, you should give each participant one or more copies of the job aid to take with them. Participants should use the job aid whenever they perform an RDT. Without the job aid, the material in this manual will not provide sufficient training.

You should not conduct the training without the job aid.

The training takes approximately 3.5 hours. Based on rapid field testing, this training, **if used with the accompanying job aid**, should be sufficient to enable most CHWs to use RDTs correctly and safely. However, RDT use should be monitored in the field to ensure good diagnostic practice and blood safety. Further revision of the material may occur following further field experience and feedback. We welcome your comments and suggestions. Please send them as an e-mail to: mal-rdt@wpro.who.int.

The ideal group size for the training is 10–15 CHWs. Conducting the training with more than 15 participants makes it difficult for a single trainer

to provide sufficient attention to each participant, particularly during sections 4 and 5. If you plan to use this material with a group larger than 15, it is strongly recommended that you work with one or more assistants who have experience using RDTs and can help you provide one-on-one attention to participants. Even with smaller groups, it would be helpful to have one or more assistants available.

What this manual contains

This manual provides step-by-step instructions for carrying out the training. The table of contents lists each section. The manual also contains a small version of the job aid, a list of frequently asked questions, sample RDTs and answer keys for those samples.

The different styles of type in this manual indicate different things:

Normal type like this is used to explain parts of the training to you, the trainer, and to describe learning objectives, activities, and sometimes specific things you should say to training participants. In some cases, this will include sentences you can read directly to participants.

Blue italic type in a box like this is used to indicate instructions to you, the trainer, about how to manage the training or what to do in a particular situation. These instructions are NOT meant to be read to participants. For example, an instruction of this type might say 'Remind participants to consult national guidelines for use of ACT.'

 *Green italic type with a red arrow pointing to it like this highlights areas that may cause difficulty or require special attention. The arrow followed by light italic type may also contain tips about how to resolve or avoid particular problems or overcome barriers.*

Purple text like this refers to questions that the trainer can ask the trainees to test their knowledge in important areas.

Text in coloured frames like this relates to topics or activities a trainer needs to cover during each section of the training.

- Gray text like this is used for devices that are not normally included with this product but may be helpful in certain circumstances.

How to use the manual

Before conducting this training, you should have enough experience using the RDT and job aid to feel comfortable carrying out each step of the test safely and correctly. You should also have a good knowledge of national policy on management of malaria-positive and malaria-negative cases of fever. If you have not used the RDT or job aid, you should seek training from someone with experience.

Once you have become comfortable and familiar with the RDT and job aid and understand national policy on the management of fever, read through the entire manual one or more times before conducting the training. Review the learning objectives and presentation material in each section. Notes on common errors and difficulties observed during development of this material are included. You may find these notes useful during your preparation and presentation. In several sections, model answers are given to frequently asked questions from trainees. These model answers are set off from the rest of the text in boxes. You may use them directly as written to work through these important issues with trainees or as a guide to ensure all these important issues are addressed in each section of the training programme. In some cases, it may be appropriate for you to adapt the model answers to reflect national management policy and the specific RDT product in use.

Gather the material and supplies you will need for the training using the list included on page 4. Use the manual as a guide to each section during the training. You are now ready to begin.

Why use RDTs?

As health programs in malaria-endemic countries implement artemisinin combination therapy (ACT), there is increasing support for parasite-based rather than clinical ('presumptive') diagnosis. RDTs can provide parasite-based diagnosis in places where microscopy is not possible or practical. Using RDTs to distinguish fevers caused by malaria parasites from those caused by other illnesses is important for at least three reasons. First, ACT is currently much more expensive than older antimalarials such as chloroquine (CQ), amodiaquine (AQ), and sulfadoxine-pyrimethamine (SP). Rather than giving these more expensive drugs to all patients with fever, RDTs can help target ACTs to patients who really have malaria. Second, many life-threatening illnesses, such as meningitis and acute lower respiratory infection, cause symptoms similar to malaria (fever, chills, malaise, aches, etc.). Treating all febrile cases for malaria means that patients with these other conditions may not get the treatment they really need. When an RDT shows that a febrile patient does not have malaria, that patient is more likely to seek diagnosis and treatment for the illness he or she does have. Finally, avoiding unnecessary use of ACTs on patients who do not have malaria may help prevent or delay drug resistance, making ACTs effective for a longer period.

However, there are still some cases in which all patients with fever should be treated for malaria. One such case is children under 5 years of age in areas with high malaria prevalence. Since infection with *Plasmodium falciparum* malaria can lead to rapid death in young children, and RDT results can sometimes be misleading, WHO continues to recommend presumptive treatment for under 5s in high malaria prevalence areas.

Why are job aids and training necessary?

With many countries facing a critical shortage of professional health workers, CHWs are a logical choice to implement RDT use. However, the package instructions provided by many RDT manufacturers are confusing and inadequate. Manufacturer's instructions often provide too little information for CHWs and other RDT users.

This manual and the accompanying job aid contain the information CHWs and other health workers need to use RDTs safely and effectively. The material included here can help improve the quality of diagnosis and the safety of both health workers and patients. However, follow-up supervision and monitoring of diagnostic practice and blood safety in the field is an essential part of RDT-based diagnostic policy.

The material included here does not address antimalarial drug therapy in detail. Rather, it assumes that CHWs and other trainees have received orientation on local and/or national drug policy, and on the side-effects and precautions of antimalarial drugs through some other module or course.

Colour plates of RDTs and quizzes have been developed to accompany this manual, and can also be down-loaded from www.wpro.who.int/sites/rdt. It is recommended that a set of pre-prepared RDTs with negative, invalid, weak positive and strong positive results also be used during the training.¹ WHO, URC and the Malaria Consortium plan additional testing of these materials, particularly to determine if they are sufficient to support safe and effective use 6 months and 1 year after initial training.

Meanwhile, we offer these materials for use by others working to promote RDT use among CHWs. We welcome your comments and suggestions, based on your own experience using these tools, and will be happy to consider incorporating them into future editions. For more information and to provide feedback, please contact:

David Bell
WHO/GMP
bellda@who.int

or:

Steven Harvey
University Research Co., LLC
sharvey@urc-chs.com

¹ Invalid RDT tests can be prepared by opening old, used RDT cassettes, and cutting and combining the nitrocellulose wicks to produce a visible line in the 'test' area with a blank wick in the 'control' area.

Materials and supplies needed for training

Item	Notes
1. RDT test packets	At least 2 per participant plus some extras to have in reserve in case some participants need additional practice. You will also need 1 or 2 packets to use yourself during the orientation.
2. Disposable examination gloves	At least 2 pairs per participant, 2 pairs each for you and anyone who will be assisting you during the training, and some extras to keep in reserve. It is not necessary to use sterile gloves to prepare an RDT.
3. Alcohol swabs	2 per participant, 2 for you to use during demonstrations, and several extras to keep in reserve. Alcohol swabs are often included in each box of RDTs. If alcohol swabs are not available, it is also possible to use cotton wool and bottles of alcohol or another appropriate disinfectant, but pre-packaged swabs are easier to handle and more convenient.
4. Sterile disposable lancets	One lancet per RDT and additional ones for demonstration and failed attempts. These are also often included in each box of RDTs or may be obtained separately.
5. Assay diluent	One dropper bottle of test assay diluent for every 2 or 3 participants. Assay diluent is generally included with RDTs by the manufacturer. Participants will not use an entire bottle during training, but logistics are much simpler if you have several bottles rather than just 1 or 2. Save partly-used bottles for future training sessions.
6. Sharps disposal bins	Ideally, you should have one sharps bin for every 2 or 3 participants. At a minimum, you will need enough sharps bins that each participant has one within easy reach so that they can dispose of their blood lancets and blood-transfer devices immediately after using them and before setting them down on the work area.
7. General disposal containers	A sufficient number of waste containers for all participants to dispose of their gloves, test cassettes, wrappers, swabs, and other non-sharps material.
8. Chairs and tables	One chair for each participant, and work benches or tables.
9. Easel and pad or white board	One easel pad or white board.
10. Pens / markers	Felt-tipped pens for use on easel pad or white-board markers for use with such boards: at least one black and one red.
11. Pencil	One pencil for each participant.
12. ARVs	Two to three initial doses of anti-retroviral (ARV) post-exposure prophylaxis to reduce HIV/AIDS risk if someone is pricked by a lancet that has already been used by another person. It is important to emphasize to participants that this is good clinical practice.
13. Anti-malarial drugs	Antimalarial drugs, in case a participant has a positive RDT result (sub-clinical infection).
14. RDT colour plates, quizzes	Colour plates of RDT results (and preferably pre-prepared RDTs), RDT quizzes, and RDT instruction sheet for every participant. <i>Important Note: All quiz colour plates must be checked carefully against the result sheet before use, as line intensity may vary between printers.</i>
15. Work space	Sufficient work area for each pair of participants to practice performing RDTs on each other. This could be one small table per pair, several larger tables with one pair working at each end and one pair in the middle, or sufficient counter space.
(Optional)	Include vials of red-coloured water for additional practice at using the blood transfer device.

Section 1 Introduction (20 minutes)

Learning Objectives

1. Participants will be able to describe a rapid diagnostic test and why the malaria control program has elected to use RDTs in the country/district.
2. Participants will be able to describe appropriate actions for RDT positive and negative results.

Topics to cover

- a. What are RDTs?
- b. Why are they important for malaria control?
- c. Limitations of RDTs
- d. Actions for positive and negative RDT results

 *You may want to have a large photograph or drawing of an RDT to show participants while you present the material in this section. In the next section, you will open and show participants a sample of the actual RDT you will be teaching them to use.*

— 1.1 —

What are RDTs?

Rapid diagnostic tests or RDTs are a way to test whether a person with malaria-like symptoms actually has malaria. Malaria is caused by a parasite that infects blood cells. The parasite is what causes the fever and other symptoms common to malaria. Malaria parasites produce chemicals (proteins) called *antigens*. RDTs detect these malaria antigens in a person's blood. If malaria antigens are present, the person will test positive. If malaria antigens are not present, the person will test negative. Different types of RDTs detect different antigens. Some antigens are produced by a single species of malaria parasite (e.g. *Plasmodium falciparum*), some are produced by all malaria species (including *P. vivax*, *P. ovale* and *P. malariae*). If present, the antigens cause microscopic particles to stick to a band on the RDT, eventually forming a visible, coloured line in the 'test' area.

— 1.2 —

Why are RDTs important for malaria control?

- In the past, most people have used two methods to diagnose malaria:
 - The first method is called 'microscopy'. Microscopy means taking a small amount of blood from the patient and looking at it under a microscope to check for malaria parasites. But many places cannot use microscopy because there is no microscope available or because there is no one trained to find malaria parasites using a microscope.
 - The second method is called 'clinical' or 'presumptive' diagnosis. Clinical/presumptive diagnosis means that health workers do not test to see if the patient has malaria parasites. Instead, they presume that anyone with fever has malaria. The problem with clinical diagnosis is that many different illnesses cause fever and other symptoms common to malaria. Many people with these symptoms do NOT actually have malaria. When everyone with fever is treated for malaria, antimalarial drugs are wasted. Even worse, people with other illnesses do NOT get the right treatment for the illness they have.

- RDTs are a simple and fast way for health workers to test for malaria parasites in a patient's blood. They are more accurate than presumptive diagnosis and can be used close to the patient's home. RDTs can also help identify patients who do not have malaria so that these patients can receive correct treatment.
- RDTs give results in about 20 minutes (check product instructions), so a patient with malaria can begin treatment right away. There is no need to wait for microscope results.
- RDTs do not require any expensive or complicated equipment. Most people can learn to use RDTs in just a few hours. Today's training will be enough for most of you to learn how to diagnose malaria safely and effectively with an RDT.

Note to trainer:

This answer may be shortened to address only the specific RDT you are using.

— 1.3 —

What are some limitations of RDTs?

RDTs are very effective for diagnosing malaria, but there are some things they cannot do:

- RDTs cannot test how many malaria parasites are present in the blood. They can only test whether parasites are present or absent.
- In fact, RDTs do not detect actual **parasites**. As mentioned before, they detect parasite **antigens**. Some parasite **antigens** (e.g., Histidine-rich protein 2, or 'HRP2') can remain in the blood for at least two weeks after the parasites are killed by drugs. RDTs that detect HRP2 cannot be used to check for effectiveness of treatment, because a person who has taken anti-malaria medication within the last two weeks will test **positive** for malaria with these RDTs even if he or she no longer has parasites.

Other RDTs detect antigens that disappear from the blood rapidly and so will usually be negative a few days after effective treatment. These include RDTs that detect plasmodium lactate dehydrogenase (pLDH) and aldolase.

- RDTs can be damaged by heat and humidity, so an RDT should not be removed from its sealed packet until right before you are ready to use it. If a package has been open for some time before the RDT is used, the RDT may be damaged by heat or humidity and give an invalid (false) result. You should discard this package and use another, unopened, package.
- To work properly, RDTs need blood and a chemical called 'assay diluent'. Adding too much or too little blood or assay diluent can cause the test to give an invalid result or be difficult to read. Adding blood and assay diluent in the wrong place can also cause an invalid result. This training will show you how much blood and assay diluent to use and where to add them. You will practice using RDTs to test one another for malaria. Pay careful attention during the training, and use the job aid during the practice session, so your tests give correct results.

Note to trainer:

This section provides a very brief summary of general treatment policy based on RDT results, and should be modified to fit the specific product in use. It is meant to reinforce instruction on how to prescribe ACTs that participants should have received prior to this training. It is NOT meant to provide a full explanation of ACT treatment policy. Details should be adjusted to reflect your country's national treatment policy.

— 1.4 —

Actions for positive and negative results

1.4.1 Testing after recent treatment:

HRP2-detecting RDTs:

Before using this type of RDT, ask the patient if he or she has recently taken anti-malaria medication.

- If the patient has taken a complete course of anti-malaria medication in the last 14 days, a positive RDT result may be misleading. It may be necessary to refer the patient to a health centre with a laboratory for further testing (consult national guidelines).

1.4.2 After you use the RDT and get the result:

- If the test result is **positive**, treat the person for malaria according to national guidelines.
- If the test result is **negative** follow national guidelines for management of febrile patients who have a negative malaria test result. These guidelines may recommend treating for common causes of fever other than malaria, further testing to diagnose other illnesses, referral to a higher level of care, or some combination of these activities. Write the result in the Clinic Register in the appropriate format (*an example should be available and explained to the trainees*).
- WHO now recommends the use of parasite-based diagnosis of malaria in all age groups, providing that the diagnostic test (e.g. RDT) is readily available, and a quality-assurance process is in place to ensure they are working effectively. Certain exceptions may apply in national policies, such as in suspected severe cases prior to referral. The national policy should be explained to the trainees.

- ***If you are not sure what to do, consult your national malaria treatment guidelines.***
- If fever persists a few days after a negative RDT result and other appropriate management, it is appropriate to re-test the patient with another RDT, as RDTs may sometimes miss early malaria infections.

Note to trainer:

RDTs occasionally give false negative results. If symptoms consistent with severe malaria are present, national guidelines may recommend presumptive treatment with antimalarial medication, while referring the patient urgently for further acute management.

It is essential that the trainer is fully aware of the national policy on treatment and action on RDT results in different age groups and situations.

In many areas, malaria is of low and/or declining prevalence, and health workers will find the vast majority of cases tested will be negative. It is important that the trainer explains this possibility, to prevent confusion over whether the tests are working. Previously, the health worker may have assumed that all febrile patients had malaria.

Section 2 How to use an RDT (60 minutes)

Learning Objective:

Participants will have a general understanding of how a malaria rapid diagnostic test is performed.

Activities to cover:

- Perform the test on a volunteer with all participants watching;
- While performing the test, explain in detail how to carry out each test step;
- Use the job aid as a visual aid for describing and explaining each test step.

- ▶ *This demonstration works best if participants are watching from close by. If you are conducting the training in a large room or if some participants are sitting more than 2–3 meters away, ask everyone to gather around the table where you are working so that they will be able to see clearly. Participants will be able to move in more closely and see more clearly if they are standing, rather than sitting, for this section of the training.*
- ▶ *Participants learn more rapidly and remember longer if they participate actively. As the trainer you should carry out the demonstration in this section to show how to perform the test correctly and safely. However, you should involve participants as much as possible in the demonstration by asking them to explain why you are doing certain steps in a certain way. For instance, when you put on gloves, you can ask, ‘Why is it important to wear gloves during this test?’ In the guide below, we note many opportunities where you can involve participants by asking them a question or asking them to do a particular task. If you think of additional ways to involve participants, don’t hesitate to use them.*

Specific steps:

— 2.1 —

As shown on the job aid, assemble all the supplies you will need, including:

- A new, unopened test packet
- A new, unopened alcohol swab
- A sterile lancet (new and unopened)



- Assay diluent



- A watch or clock to use as a timer



- A new pair of disposable examination gloves



- Pencil



- A sharps disposal container



- A non-sharps disposal bin



Note to trainer:

Optionally, include vials of red-coloured water for additional practice at using the blood transfer device.

— 2.2 —

Place all these supplies on a table where they will be visible to all participants.

Point out the list of supplies on the job aid, then point to each one on the table and identify it for the participants.

— 2.3 —

Ask for a volunteer from among the participants.

This person will act as the 'patient'. He or she will help you demonstrate how to perform the RDT.

— 2.4 —

Explain the importance of the expiry date.

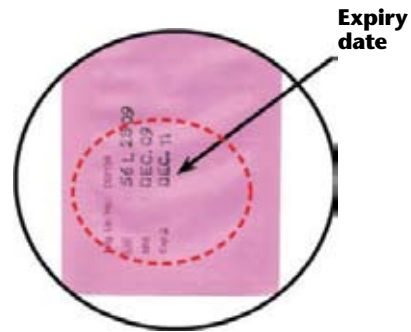

2.4.1 Point out the expiry date on the test packet, but do not read the date.

2.4.2 Pass the test packet around and ask each participant to look at it.

2.4.3 Once all participants have had a chance to look at the expiry date on the packet, ask them, **'What is the expiry date?'**

- If the first person to answer gives the correct expiry date, ask the others **'Does anyone disagree?'**

If anyone suggests a different date, have the participants discuss among themselves which date is correct and why. Once the participants reach a consensus (or once it becomes clear that the participants cannot resolve the disagreement), tell them the correct date, point out its place on the packet again, correct any mistakes and answer any questions.

- If the first person to answer gives the incorrect expiry date, ask the others, **'Does anyone disagree?'**

Have the participants discuss among themselves which date is correct and why. Once the participants reach a consensus (or once it becomes clear that the participants cannot resolve the disagreement), tell them the correct date, point out its place on the packet again, correct any mistakes and answer any questions.

- ▶ *Field tests show that many CHWs do not immediately understand the concept of an expiry date, naturally enough since their environments do not commonly have such dates. Also, many have trouble finding the expiry date on the packet or forget to read it before carrying out the test. You should emphasize repeatedly the importance of checking the expiry date and not using an expired RDT. Ask questions of the participants and allow them to ask questions until you are sure everyone understands.*

— 2.5 —

Put on a new pair of examination gloves.



As you are putting them on, ask participants: **‘Why is it important to wear gloves when doing the test?’** Be sure someone mentions the following two points:

- 2.5.1 Protect CHWs from possible infection with blood-borne diseases, including HIV-AIDS.
- 2.5.2 Protect patients from possible infection with blood-borne diseases, including HIV-AIDS.

— 2.6 —

Open the test packet and remove the contents.

As you remove each item, hold it up so that everyone can see it. Explain how it is used:

- 2.6.1 The sample pipette is used to collect blood and transfer it to the test cassette.

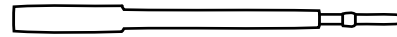

- 2.6.2 The desiccant protects the test from humidity before the packet is opened.



Once the packet is opened, the desiccant sachet serves no purpose and should be discarded. It may be harmful if swallowed, so it should be kept away from children.

- 2.6.3 The test cassette is used to conduct the test. Pass the cassette around and ask everyone to look at it. Explain the holes and the markings and what each one means:

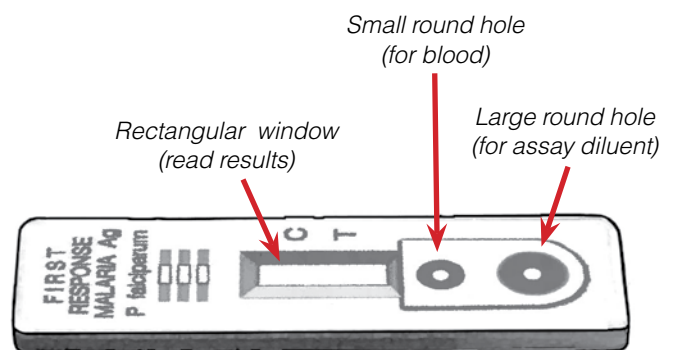

For example:

- The small round hole is where you put the blood.
- The large round hole is where you put the assay diluent.
- The rectangular window is where you read the results.

— 2.7 —

Write the patient's name on the cassette.

Explain to participants why it is important to write the patient's name on the cassette before beginning the test.

There will probably be times when you have many patients waiting to be diagnosed. You won't be able to wait to get each patient's result before testing the next one. If you are testing several people one after another, you will need to have their names written on their cassettes so you don't run the risk of mixing up one person's results with those of another. Even when you have only one patient to test, it is good practice to write his or her name on the cassette so you develop the habit of doing it and don't forget to do it when you are busy and have many patients.

— 2.8 —

Open the alcohol swab. Clean the patient's 4th finger.

Clean the patient's 4th finger. Explain these important steps to using the alcohol swab:

2.8.1 Ask the patient: **'Are you right-handed or left-handed?'** If the patient is right-handed, choose the 4th finger on their left hand.

If the patient is left-handed, choose the 4th finger on their right hand. This will cause the least inconvenience to patients if the pricked finger becomes sore.

2.8.2 The 4th finger is preferred because for most people it is the least-used finger.

Pricking this finger will cause the least inconvenience for most patients because if it becomes sore, it will not interfere with their work. Also, since it is least used, it may be less likely to become infected later. Further, the skin on the 4th finger may be thinner. Other fingers may be used if necessary.

⊕ *Be sure that participants understand that by the 4th finger, we mean the one closest to the little finger (see illustration). In some places, people count fingers beginning with the little finger and ending with the thumb instead of the other way around. If some of your participants are accustomed to counting this way, they will mistakenly identify the index finger as 4th finger.*

2.8.3 After cleaning the finger with the alcohol swab, it must be allowed to **air dry**.

The finger **must not** be dried by blowing on it or wiping it with a piece of cloth or paper. Do not allow the participant to blow on it. Ask participants: **'Why must you not blow on or wipe the finger once it is cleaned?'** Make sure they understand that blowing on or wiping the finger means it will no longer be clean.

2.8.4 After using the alcohol swab, place it on its wrapper and set it aside on the table. You will use it again to stop the bleeding after you collect the 'patient's' blood.

— 2.9 —

Once the patient's finger is dry, open the lancet.



Prick the patient's finger, preferably towards the side of the pulp (ball) of the finger. Pricking the midline or tip is more painful. Check to be sure the finger-prick will produce enough blood, then discard the lancet in the sharps container. Remind participants that every time they use a lancet, they must take **all** of the following steps to ensure blood safety:



- Discard the lancet in an appropriate sharps container **immediately** after using it.
- **Never** set the lancet down before discarding it.
- **Never** discard the lancet in a non-sharps container.
- **Never** use a lancet on more than one person.

You will need to make these points quickly so your volunteer 'patient's' blood does not coagulate before you can collect it. You will have time to make them again and discuss them in more detail when you present the next section.

Note to trainer:

Post-exposure prophylaxis for HIV: When lancets are used carefully and strictly according to the above instructions, there is minimal risk of finger-prick injury to the user or other people. However, should an accident occur and a person receives a finger prick with potentially infective material, it is essential that the current national policy for post-exposure prophylaxis be followed promptly. Trainers should familiarize themselves with this policy prior to conducting the training, and ensure that the trainees are fully aware of the policy and where they can access PEP if required.

— 2.10 —

Demonstrate how to collect the droplet of blood using the blood collection device included with the RDT you are demonstrating:

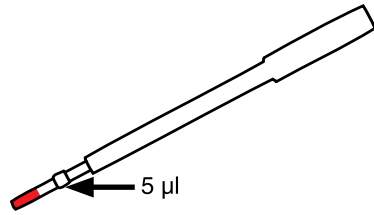
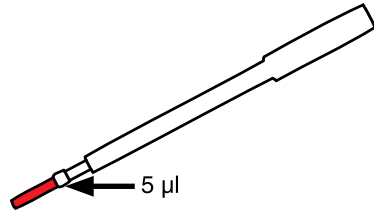
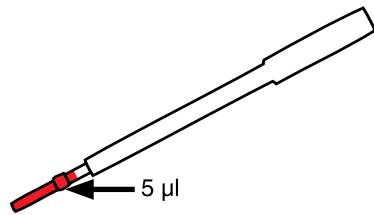

PIPETTETOO LITTLE
BLOODCORRECT
AMOUNT
OF BLOODTOO MUCH
BLOOD**Pipette:**

Ensure a good-sized drop is on the finger before collecting. Collect just to the mark. Do not lift the tip of the pipette as this will allow air bubbles to enter.

In some cases, the test packet may contain a different type of blood collection device.

Loop:

- Turn the 'patient's arm so their palm is facing downward.
- Squeeze the pricked finger and allow a drop to well up below the finger tip.
- Use the loop to collect the drop from underneath. Explain that it is easier to collect the correct amount of blood this way. Many participants attempt to collect the blood from above with the palm of the hand facing upwards. It is often difficult to collect enough blood this way.
- Explain that the loop must contain a film of blood completely across it and show participants what the loop looks like with the correct amount of blood.
- Explain that it is not necessary to collect a large amount of blood. The loop should be just full with a thin film but should not hold a large drop.
- Once you have collected a sufficient amount of blood, you may hand the alcohol swab back to the patient and show him or her how to use it to stop the bleeding.

Straw:

- As above, but finger may be palm-up. There should be only a thin film of blood across the opening of the straw.

Capillary tube:

- Ensure a good-sized drop is on the finger before collecting. Collect just to the mark by placing the tip of the capillary tube on the blood drop of finger. Do not lift the tip of the tube as this will allow air bubbles to enter.

— 2.11 —

Use the device to add blood to the small round hole.

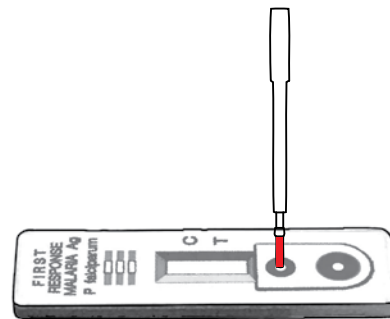

2.11.1 Explain that the blood needs to reach and be absorbed by the pad at the base of the hole.

If the blood is mostly deposited on the plastic edges of the well, but does not reach the pad, the test will not work correctly.

2.11.2 Explain the use of the blood-transfer device in more detail.

- Gently squeeze the bulb of the pipette and touch the tip to the drop of blood. Then gently release the bulb to draw the blood up to the black line on the pipette.

If using a device other than a pipette:

- A loop can be a bit flimsy and it takes some practice to learn how to use it correctly.
- Capillary tubes can fail to deliver blood if air bubbles are introduced into, or below, the blood column, so a large drop must be accumulated on the finger before sampling.
- Straws should collect only a film across the end (rather than a column of blood as a capillary tube or pipette does).

- Some RDT users have been observed sucking blood into the straw or capillary tube. This is incorrect and dangerous. Remind participants that they should NEVER suck blood into the blood-collection device.

2.11.3 Explain and demonstrate how to introduce the blood into the hole.

- Transfer the blood to the test cassette by touching the nozzle to the small sample well and gently squeezing the bulb of the pipette.

If using a device other than a pipette:

- With a loop, deposit the blood in the correct place by pushing the loop vertically into the hole until its tip touches the pad at the base. Then push down slightly, bending the tip of the loop so that a larger part of its surface touches the pad. Take care not to allow any blood to be flicked up when pushing on the loop.
- A capillary tube must be touched on the pad and remain there until all blood has left the tube (lifting off for a moment will introduce air bubbles and result in poor blood transfer).

2.11.4 Hold up the test so that all participants can see how you have added the blood to the test and how the pad is absorbing it.

Show that the blood is on the pad and not just on the plastic walls of the cassette.

Note to trainer:

As an option to practice use of the blood transfer device, the trainer may consider including a vial of red-coloured liquid. This may be placed on a finger to simulate a blood drop. Note that with some transfer devices such as loops, the device may not function effectively as water has a lower viscosity than blood.

— 2.12 —

Explain and demonstrate how to discard the blood collection device after use.



Participants should understand that they must discard the blood transfer device in the sharps box immediately after they transfer the blood to the test cassette. They should not set it down on the table or elsewhere before discarding it.

➤ *In field trials carried out during the preparation of this manual, some CHWs had trouble handling the lancet and the loop because their hands were shaking. Many were nervous because they had never done a finger prick. Others had trouble manipulating the loop into the small blood well. If you observe this during section 4 when participants are practising RDT use, encourage the participant to relax and reassure them that it becomes easier with practice.*

— 2.13 —

Explain and demonstrate how to add assay diluent to the cassette.

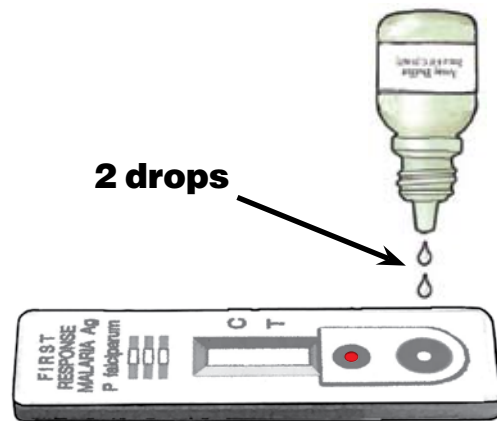

2.13.1 Ask participants: **'Where do we add the assay diluent?'** Remind them that the assay diluent must be added to the large round hole.

2.13.2 Explain that they need to add exactly the correct number of drops of assay diluent. Ask them: **'How many drops of assay diluent do we add to the cassette?'** (Correct answer: 2 drops for this specific product.)

Tell them to watch closely as you add the assay diluent. Hold the bottle vertically (see illustration) — this ensures the correct drop size. To reinforce the correct number of drops, it may help to have participants count them out loud as you add them.

— 2.14 —

Wait the correct time (e.g., 20 minutes) after adding assay diluent before reading test results.



- After adding assay diluent, ask participants: **‘What is the time now?’**
- Ask participants to write down the time of day on a note pad or piece of scrap paper.
- Ask for a volunteer to be responsible for telling the group when the correct time (e.g., 20 minutes) has passed. Make sure this volunteer has access to a watch, clock, or other timer.
- Ask participants: **‘What time will it be when the correct time has passed?’** Ask them to write this time down on their note pad or scrap paper next to the start time.
- Once participants have recorded the time at which they can read the test results, have them look at the cassette.
- Point out to them how the blood is beginning to wick up the strip, disappearing from the hole where it was added and beginning to appear in the results window.
- Explain that the blood will eventually disappear from the results window as well, leaving only the red control line and the results line (if the patient is positive).
- It is not necessary for participants to understand every detail of how the test works. But understanding the basic idea of how the assay diluent washes the blood up the test strip will help them understand why they need to wait the correct time before reading the test results: explain that if there is too much blood left in the results window, they have not allowed enough time, and they will not be able to see the results line clearly.

— 2.15 —

Remove and discard your gloves at this time.



- Explain to participants that once the assay diluent is added to the cassette, gloves are no longer needed for their or their patient's safety.
- To avoid possible contamination, the used gloves should be discarded in the non-sharps container before the CHW does anything else.
- If a CHW is going to begin a new RDT to diagnose another patient while waiting for the first patient's results, he or she must put on a new pair of gloves.
- If the CHW will do another activity that does not involve handling blood or bodily fluids while waiting for the first patient's results, he or she should not wear gloves.
- In either case, the used gloves should be discarded before moving on.

Keeping the gloves on may result in unseen blood contamination of pens, paper and other materials, and potential ingestion of blood-borne viruses.

— 2.16 —

Reading test results 1: The different possible results and what they mean

- ▶ Present this step while you are waiting the correct time before reading test results.

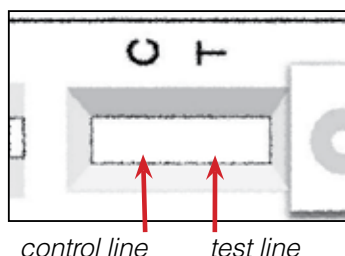

- Use the easel pad or white board and magic markers to draw all 4 possible results:
 1. A line in 'T' and a line in 'C' = Positive (Note: test is positive even if the line in 'T' is very faint.)
 2. No line in 'T' and a line in 'C' = Negative
 3. A line in 'T' and no line in 'C' = Invalid
 4. No line in 'T' and no line in 'C' = Invalid
- Explain that an invalid result means the RDT is damaged and the results may be incorrect. Ask participants: **'What should you do when this happens?'** (Correct answer: Discard the cassette. Open a new cassette and repeat the test using the new cassette.)
- Ask participants: **'What should you do in case of a positive result?'** (Correct answer: Treat for malaria according to national guidelines.)
- Ask participants: **'What should you do in case of a negative result?'** (Correct answer: Do not treat for malaria; refer to a health centre or hospital for further testing.)
- Discuss the national malaria treatment policy with participants, including policy on treatment of febrile children under 5 years of age.

— 2.17 —

Reading test results 2: What is the actual result of the RDT you have just demonstrated?

- Once the correct amount of time has passed, you should proceed to reading the actual test results.

- First, read the result yourself, but **DO NOT** yet tell the result to participants.
- Pass around the cassette. Ask all participants to look at the cassette and, without speaking, write down what they think the correct diagnosis is on a piece of paper. Each participant should decide the result himself or herself. Participants should not discuss their interpretation of the test with each other.
- Once all participants have seen the cassette and written down their result, ask them these questions. Ask for a show of hands:
 - **Who thinks the result is positive? Why do you think the result is positive?**
 - **Who thinks the result is negative? Why do you think the result is negative?**
 - **Who thinks the result is invalid? Why do you think the result is invalid?**
- Explain the correct result. Explain why that result is the correct one.
- Pass around the cassette again. Tell those who answered incorrectly to look carefully at the test and note why the actual result is correct (e.g., if people said negative, but the test line is faint meaning the real result is positive, or if people said negative when no control line appeared meaning the real result is invalid.)
- As they examine the cassette a second time, tell everyone to note that the test strip is now white or nearly white because the blood has wicked its way past the results windows.
- Explain that if they try to read the result too early, the test strip will still be red and it will be difficult to tell if the test is positive.
- Show the participants the colour plates of RDT interpretation (and samples of used RDTs if you have them).
- Ask participants: **'How many of you own a watch, a clock, or a timer?'** Ask them further: **'How will you measure the correct time when you are working in your own home or village?'**

Section 3 How to take a finger-prick blood sample

(30 minutes)

Learning Objective:

Participants will be able to demonstrate the correct technique for drawing blood safely and effectively with a finger prick, including the reasons for universal precautions.

- ▶ *CHWs who have never collected a finger-prick blood sample need specific instructions and practice to master the technique. The purpose of this section is to demonstrate how to handle the lancet and collect the blood sample effectively while minimizing pain for the patient and minimizing infection risk for both the patient and CHW.*
- ▶ *As in the previous section, participants should watch from close by. If you are in a large room, or if some participants are sitting more than 2–3 metres away, ask them to gather around the table so that they will be able to see clearly.*

Activities to cover:

Ask for a new volunteer from among the participants to play the role of 'patient.' Using this volunteer, describe and demonstrate the elements of effective finger-pricking to collect a small quantity of blood.

— 3.1 —

Put on gloves before beginning. Use a new pair of gloves for each patient. Do not re-use gloves.

- Ask participants: **'Why is it important to wear gloves?'** Answer: To protect ourselves and the patient against potential infection with blood-borne disease.
- Ask participants: **'Is it OK to use gloves on more than one patient? Why?'** Answer: Gloves should never be used on more than one patient because they could expose the second patient to an infection from the first. You must use a new pair of gloves with each patient.

— 3.2 —

Select an appropriate finger (i.e., 4th finger of left hand—explain which is the 4th finger using the job aid to illustrate).

- Ask participants: **'Why should we use the 4th finger?'** They should remember from the previous section that people generally

use their 4th finger less than the others. We select it for drawing blood because it minimizes inconvenience to the patient.

- Instruct participants: **'Identify your 4th finger.'** They should remember from the previous section that the 4th finger is the ring finger, not the index finger: we count from the thumb to the little finger, not vice-versa.
- Ask participants: **'Which of the patient's hands should you use to draw blood?'** They should remember from the previous section to use the left hand if the patient is right-handed and the right hand if the person is left-handed.

— 3.3 —

Clean the finger with alcohol to prevent infection.

- Demonstrate and explain appropriate cleaning technique: wipe the entire first joint of the finger with the alcohol swab, paying particular attention to wetting the pulp (ball) and sides of the finger tip.

— 3.4 —

Allow the finger to air dry.

- Ask participants: **‘Is it OK to blow on the finger to dry it more quickly?’**
Answer: No, this would re-contaminate the finger with germs from the breath.
- Ask participants: **‘Is it OK to dry the finger with a cloth or piece of paper (e.g., toilet tissue)?’** Answer: No, this would re-contaminate the finger with germs from the cloth or paper.

— 3.5 —

Open the lancet immediately prior to use. Once the lancet is open, do not set it down.

The following mistakes are common among people with little or no experience handling a blood lancet:

- The provider opens the lancet before cleaning the finger, then sets the lancet down on the table while cleaning the finger.
- The provider opens the lancet before cleaning the finger, then tries to hold on to the lancet while cleaning the finger.
- The provider opens the lancet without paying attention to where the point is located, thus exposing himself or herself to an accidental finger-prick.

— 3.6 —

Prick the side of the finger (not directly on the pulp or ball). Stab firmly and deep enough to draw an adequate amount of blood.

The following mistakes are commonly observed among health workers inexperienced at taking finger-prick blood samples. The first two generally happen because the provider is nervous about pricking the patient:

- The provider stabs too lightly and either fails to puncture the skin entirely or creates a puncture too small to collect a sufficient amount of blood. This results in the need for a second or third or fourth prick.

- Rather than stabbing, the provider places the point of the lancet on the patient’s finger and attempts to push it through the skin. This is ineffective, especially with patients whose fingers are calloused. It is more painful to the patient than a quick, firm stab.
- The provider stabs the centre of the finger tip rather than the side or stabs too close to the nail bed.

— 3.7 —

Dispose of the used lancet safely in the sharps box. Do not set it down before disposing.

- Inexperienced providers often set the lancet down on the table before discarding it. Ask participants: **‘Why should you NOT set down the lancet on the table?’** Answer: It increases the risk that they will prick themselves when they pick the lancet back up, thus exposing themselves to potential infection from the patient. Also, it may be forgotten and put others at risk later.
- Inexperienced providers sometimes forget to discard the lancet in an appropriate sharps container and instead discard it in a normal waste container. Ask participants: **‘Why must you use a sharps container and not discard the lancet with normal waste?’** Answer: If they discard the lancet with normal waste, they put themselves and any others who handle the waste at risk of infection through a puncture wound.
- Emphasize the importance of using an appropriate sharps container and remind participants of your health system’s policy for disposing of full sharps containers.
 - In some health systems, the district health management team (DHMT) collects used sharps containers from CHWs and incinerates them.
 - In others, the DHMT instructs CHWs to dispose of sharps in a pit toilet.
 - Ask participants: **‘Why must you NOT dispose of sharps in a normal rubbish pit?’** (Answer: Because children and others could come into contact with contaminated sharps there.)

Section 4 Perform a malaria rapid diagnostic test

(60 minutes)

Learning Objective:

Participants will develop the skill to safely and effectively perform an RDT using the job aid as a guide.

Activities to cover:

- Divide the trainees into groups of 2 or 3 depending on the number of trainees. (If you have 10 or fewer trainees, have them work in groups of 2; if you have more than 10, have them work in groups of 3.)
- Within each group, participants take turns performing an RDT on one another using the job aid as a guide.
- Each group member must perform **correctly a minimum** of one RDT. Correct performance means completing **all** crucial steps correctly.

Each group will need the following supplies:

- 2 new sealed RDT test packets *per participant* (that is, a total of 4 packets for groups of 2 CHWs or a total of 6 packets for groups of 3; similar calculations must be made for the next few supply items)
- 2 new pairs of examination gloves per participant
- 2 alcohol wipes per participant
- 2 lancets per participant
- 1 bottle of assay diluent
- 1 sharps disposal bin
- 1 general disposal container
- 1 clock or watch (if one of the participants in each group has a watch, ask them to allow group members to use it as their timer)
- 1 copy of the job aid
- 1 pencil per participant

Specific steps:

— 4.1 —

Distribute supplies to each group of 2 to 3 participants.

— 4.2 —

Instruct participants within each group to take turns performing the RDT on each other.

Each member of the group should perform one RDT. Next, after each participant has completed one RDT, the group should begin again until each participant has performed the whole procedure at least twice.

— 4.3 —

Instruct participants to FOLLOW THE JOB AID as they complete their RDTs.

— 4.4 —

Instruct participants to KEEP THEIR CASSETTES once they have finished so you can check the results in the next section. DO NOT DISCARD cassettes at this stage.

— 4.5 —

Once a participant has added assay diluent to their RDT and noted the time for reading results, the next participant should begin the next RDT.

(Otherwise, if the group were to wait until results appear for one RDT before beginning the next, this section would take about an hour.)

— 4.6 —

After each RDT is completed, group members should discuss which steps the CHW performing the test completed correctly and which steps incorrectly.

— 4.7 —

You, as the trainer, should rotate among all the groups, observe each participant's technique, and provide coaching and assistance as necessary.

- ▶ *You may want to ask several health workers with RDT experience to help you provide assistance and coaching. If you have a sufficient number of helpers, you can assign each helper to one or two groups.*
- ▶ *Don't forget to provide encouragement and reassurance for CHWs nervous about performing a finger-prick for the first time.*

— 4.8 —

Once each CHW has completed 2 RDTs, bring all participants back together in 1 group.

- Ask participants to talk about their experiences carrying out the RDTs.

- Ask what steps they found easy.
- Ask what steps they found difficult.
- Once participants have had a chance to discuss and ask questions, point out any important issues you observed during the practice session (e.g., people seemed to have trouble collecting the blood from the finger, or everyone remembered to dispose of their lancet in the sharps box, etc.).
- If you had helpers, ask what they observed.

- ▶ *This orientation is **competency based**: each participant must **demonstrate** that he or she can perform the RDT correctly and safely, and interpret results correctly, before being allowed to use RDTs in their own village or catchment area. Participants who have not demonstrated correct and safe procedure should keep practising until they do.*
- ▶ *Make arrangements to provide treatment according to national guidelines for any participants who tested positive.*
- ▶ *Any participant suffering a lancet-prick injury should be started on HIV/AIDS prophylaxis.*

Section 5 Read test results (45 minutes)

Learning Objective:

Participants will gain proficiency at correctly interpreting the different possible RDT outcomes.

Activities to cover:

- Explain the three possible test results (positive, negative, invalid) using the job aid as a guide.
- Ask participants to interpret the results of their own tests. Check to make sure they have interpreted correctly.
- If you have sufficient number of used RDTs that show all different possible results, you may use those actual RDTs for this section. Otherwise use the sample tests provided on pages 28–30 of this manual.
- Hand each participant a copy of sample test #1 (on page 28). Ask them to determine the results of each test and record it on the blank answer sheets provided on page 34.
- Grade the score sheet and discuss the different types of results, especially faint positives and invalids.
- Repeat the quiz using sample test #2 (page 29) and score it again to see if interpretation has improved. Repeat a third time using the sample test #3 (page 30) if some participants are still misinterpreting results and need additional practice.

▶ Before beginning, ensure that the room has good lighting.

Note to the trainer:

Photographic quizzes are provided with this manual, but sets of real used RDTs may also be made, and this may prove more effective. These sets must include examples of weak positive and invalid results. Weak positive results may be obtained through serially diluting parasitized blood if necessary, while invalid results may be manufactured by opening the cassette and modifying the nitrocellulose wick.

Specific steps:

— 5.1 —

Start by going back over the pictures you have drawn on the easel pad. Instruct participants to follow along by looking at the pictures of different test results at the bottom of their job aids.

5.1.1 Review different possible results. (If needed refer to the figure on page 16.)

- A line in '**C**' AND a line in '**T**' means the patient **DOES** have *falciparum* malaria.

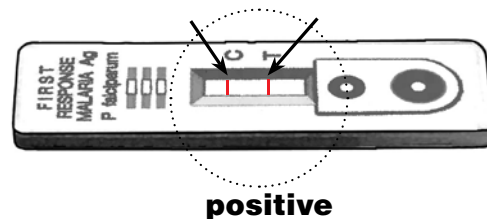

The test is **POSITIVE** even if the line in '**T**' is very **faint**.

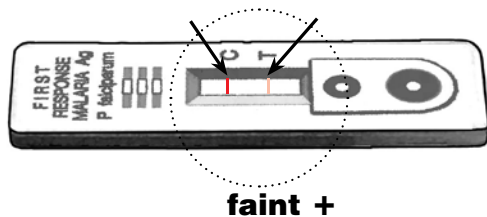

- A line in **'C'** and **NO LINE** in **'T'** means the patient **DOES NOT** have *falciparum* malaria.

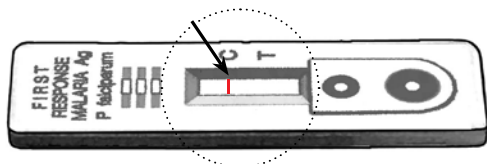

negative

- **NO LINE** in **'C'** means the test is damaged. Results are **INVALID**.

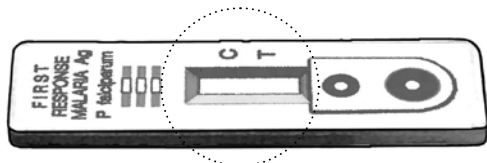

invalid

- A line in **'T'** and **NO LINE** in **'C'** also means the test is damaged. Results are **INVALID**.

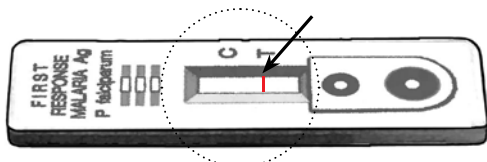

invalid

- 5.1.2 Ask participants: **‘What do you do in case of an invalid result?’** (Answer: Repeat the test using a new RDT).

— 5.2 —

Ask participants to write down on a piece of paper the results from the RDTs they completed in the last section and the immediate action they would take as a result.

If participants have brought their CHW register to the orientation session, they should write the results in the register just as they would write results for a regular patient.

Rotate among all the groups and check to make sure that all participants have recorded their results correctly. If you have assistants, they may help you with the checking.

➤ *During testing, poor vision can make it difficult for some CHWs to interpret results correctly, especially in the case of faint positives. As you circulate, try to determine if this is a problem for any of your participants.*

➤ *Even with excellent vision, faint positives can be difficult to detect in dim light. If they are like most CHWs, some of your participants are likely to be working in dim light (e.g., trying to determine a test result at night in a setting with no electric lighting). Remind participants that they will need to have sufficient light at night: a strong flashlight or kerosene pressure lantern bright enough to illuminate even a faint positive result.*

— 5.3 —

Pass out the first sample set of RDTs. Ask participants to note on a piece of paper the results for each of the 10 tests in the first set.

— 5.4 —

Once participants have finished writing down results for each of the 10 tests, they should write their name on their paper and pass it on to you.

— 5.5 —

Review the correct answers:

- Call on a participant and ask him or her for the results from test #1. After the participant has given what he or she thinks is the correct test result, ask if anyone wrote down anything different. Tell participants the correct result from test #1. Explain how you determined this result.
- Repeat this process with test #2. Continue in the same way with subsequent tests until completing all 10.

— 5.6 —

Pass out the second set of sample tests and have CHWs repeat steps 3 and 4 above.

— 5.7 —

While participants work on the second set, grade the results from the first.

Determine overall total correct for each participant (# of correct answers ÷ 10). See if many people answered one or more tests in particular incorrectly. (People often read faint positives as negatives.)

— 5.8 —

Review the correct answers as in step 5 above.

— 5.9 —

If necessary, repeat steps 3–8 with the third set of sample tests.

Successful completion of Section 5 concludes this orientation.

Frequently asked questions

During the testing period for this orientation, participants asked the following questions:

Q: Can I use an RDT on more than one person?

A: No. Each cassette may be used only once. You need a new, unopened cassette for each patient. If you get an invalid result from one cassette, you need a new, unopened cassette to retest the same patient.

Q: Is it possible to get a positive result if the patient doesn't really have malaria.

A: Yes. If the patient has taken malaria medication in the last 14 days, he or she may test positive with some RDTs even if he or she no longer has malaria. The test works by detecting an antigen, a substance in the blood produced by malaria parasites that remains in the body for some time after the parasites have been killed.

HRP2 antigen can remain in the blood for 2 weeks or more after all the parasites have been killed. So before using an RDT on a febrile patient, you must ask the patient whether he or she has taken malaria medication within the last 2 weeks. If so, you should refer the patient to a health centre with a microscope.

RDTs that detect other antigens (pLDH, aldolase) will usually be negative by 5 days after effective treatment. So before using an RDT on a febrile patient, you must ask the patient whether he or she has taken malaria medication within the last 5 days. If so, you should refer the patient to a health centre with a microscope.

Occasionally, false-positive RDT results can occur for other reasons. However, this is rare. Since antimalarial medicines are safe when prescribed correctly, the occasional unnecessary treatment that occurs as a result will not harm the patient.

Whatever the result of the RDT, it is always important to remember that a patient may have other diseases in addition to or instead of malaria.

Q: If I don't have assay diluent, can I use plain water or some other liquid to perform an RDT?

A: No. Assay diluent is the only liquid that will work.

Q: If I don't have an alcohol swab, can I use cotton wool and sterilizing alcohol (spirit) to clean the patient's finger?

A: Yes, you can use cotton wool and sterilizing alcohol instead of an alcohol swab. As with the swab, you should not blow on the finger or dry it with anything.

Q: What if I don't have lancets but have all the other materials I need? Can I still do the test?

A: If you do not have lancets, you can use a sterile hypodermic needle from an unopened package to do the finger-prick. Once you have used the needle, you must discard it in your sharps box just as you would a lancet. The essential thing is that the instrument **MUST** always be sterile and unused.

Q: If I don't have a lancet, can I use a new sewing needle to do the finger prick?

A: No. A sewing needle would not be sterile. A sterile lancet or a hypodermic needle from a sterile packet are the **only** things you can use to do a finger prick. Also, you must use a lancet only **once and discard it immediately after the finger prick, even before collecting the blood. Never** use a lancet or hypodermic needle on more than one patient.

Q: What if the RDT result is negative but the patient still asks me for malaria medication?

A: A patient more than 5 years old who tests negative, is very unlikely to have malaria. If you **strongly** suspect there is something wrong with the test that gave a negative result, you may repeat the test once using a new RDT, but this should **rarely** be necessary. If the second test is also negative,

the patient's symptoms are probably due to some other illness. You should refer him or her to a health centre for further testing and follow the appropriate national guidelines.

The exception is when a patient has symptoms consistent with **severe** malaria. In this case, it is appropriate to treat him or her with antimalarial drugs **while referring** them on immediately for further assessment. Delayed treatment of severe malaria may result in death, and RDT results are occasionally wrong. **(Consult national treatment policy.)**

(Note: you should re-test a patient ONLY if you have some reason to think that the first test was invalid. You should NOT test every negative patient twice.)

Q: Why do I have to remove my gloves immediately after adding assay diluent to the RDT?

A: The gloves may have become contaminated with blood while you were doing the test. If you touch something while waiting for the test results, you could contaminate it with the gloves. If you examine other patients while you are waiting, you cannot keep wearing the gloves you have used with one patient while you attend another. Even if you are just sitting and waiting, blood on the gloves may contaminate other objects (such as pens) and eventually be ingested. Use a new pair of gloves with each patient.

Q: Is it OK to throw gloves, wrappers, and other waste material in the sharps box?

A: No. If you dispose of gloves and other non-sharps in the sharps box, it will fill up very quickly. Once it is full, you won't have an appropriate place to discard sharps. You may discard the *pipette (loop, capillary tube, straw)* in the sharps box because it is small and heavily contaminated with blood. Other than the blood-transfer device, the lancet is the only thing you should throw in the sharps box. Other waste materials can be burned or buried in a rubbish pit. However, these other materials should be considered contaminated with blood and kept away from

children and animals. They should be handled and disposed of according to national policy.

Q: Do I need to write down the time when the patient arrives?

A: No. After you add the assay diluent to the cassette, you should write the time the assay diluent was added and the time the results will be ready (for example, 20 minutes, depending on the RDT, after the assay diluent was added) on the test cassette. This is especially important if you are testing several patients in a row. You do not need to record the patient's arrival time.

Q: Why do you write down the time after adding the assay diluent and not after adding the blood?

A: The test only begins to work after you add assay diluent. Thus, you need to wait the correct time after adding the assay diluent, not after adding the blood. However, assay diluent should be added to the RDT immediately after adding the blood, before the blood dries.

Q: How long will results remain visible?

A: The results remain visible for at least one hour after testing, but the RDT should be read as close as possible to the time stated in the instructions (e.g., 20 minutes). After several hours, negative RDTs may sometimes appear positive. This is a false result.

Q: Does the test detect all kinds of malaria or just falciparum malaria?

A: The First Response Malaria Pf RDT detects only falciparum malaria.

Q: Can I puncture the patient's finger anywhere, as long as I choose the 4th finger?

A: The best place to puncture is on the side of the finger tip, but not too close to the nail. Puncturing in other places causes more pain to the patient and may increase the risk of infection. However, if there is some reason

why you cannot puncture the 4th finger, you may puncture some other finger instead.

Q: Can you throw out the lancet anywhere after using it?

A: No. You should discard the lancet ONLY in an approved sharps box. Discarding the lancet in an approved sharps box reduces the risk of someone being injured or infected by accidentally stabbing themselves.

Q: Why do children seem to get malaria more frequently than adults?

A: In areas with a lot of malaria, most adults have been exposed to malaria many times. Their bodies have developed partial immunity to malaria. This means they often do not feel sick even if they have some malaria parasites. Children's immunity is not fully developed, so they are more likely to become ill when infected with malaria.

Q: The cassette has 3 small rectangular holes on one end. What is the purpose of these holes?

A: The holes allow ventilation to dry the blood after it has passed up the test strip inside the cassette. You do not need to use these holes in any way while you are performing the test. Do not add blood, assay diluent, or any other substance to these holes.

Q: What do the markings on the RDT mean?

A: The large round hole is where you put the assay diluent. The small round hole is where you put the blood. The rectangular window is where you read the results. The line that forms near 'C' is called the 'control line'. This line will form if the test is performed correctly. The test is negative if only the control line appears. The test is positive when a line other than the control line appears. The test is invalid if no control line appears whether or not a line in 'T' is present. If this occurs, repeat the test using a new unopened cassette.

Other useful reference materials

WHO, *The Use of Malaria Rapid Diagnostic Tests*. 2nd ed. 2006, Manila: World Health Organization – Regional Office for the Western Pacific.

WHO, *Malaria Rapid Diagnostic Tests: Making Rapid Diagnosis Work*. 2006, <http://www.wpro.who.int/rdt/>.

National Malaria Control Service Guidelines on malaria management (essential).

Product instructions provided by manufacturer. (Always review manufacturer's instructions before beginning your training, and clarify these instructions whenever necessary.) WHO can assist with modifying the course manual and instructions where appropriate; contact country WHO office or mal-rdt@wpro.who.int).

How To Do the Rapid Test for Malaria

Modified for training in the use of the **First Response Malaria HRP2 (I13FRC30) Test for falciparum malaria**



Collect:

- NEW unopened** test packet
- NEW unopened** alcohol swab
- NEW unopened** lancet
- NEW** pair of disposable gloves
- Assay diluent
- Timer
- Sharps box
- Pencil or pen

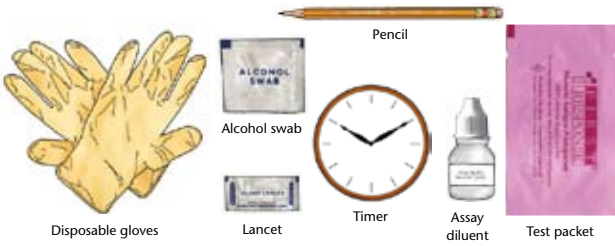

READ THESE INSTRUCTIONS CAREFULLY BEFORE YOU BEGIN.

- 1.** Check the expiry date on the test packet.

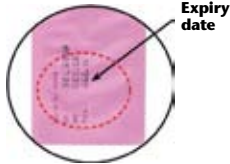

- 2.** Put on the gloves. Use new gloves for each patient.



- 3.** Open the packet and remove:

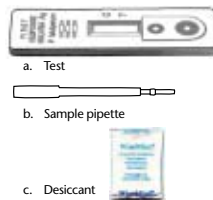

- 4.** Write the patient's name on the test.



- 5.** Open the alcohol swab. Grasp the 4th finger on the patient's left hand. Clean the finger with the alcohol swab. Allow the finger to dry before pricking.



- 6.** Open the lancet. Prick patient's finger to get a drop of blood. Do not allow the tip of the lancet to touch anything before pricking the patient's finger.



- 7.** Discard the lancet in the Sharps box immediately after pricking finger. **Do not set the lancet down before discarding it.**



- 8.** Wipe away the 1st drop with sterile gauze or cotton (not provided). Gently squeeze the bulb of sample pipette and touch its tip to the next drop of blood. Gently release the bulb to draw blood up to the mark.



- 9.** Touch the tip of the sample pipette to the small round hole. Squeeze gently to transfer the blood.

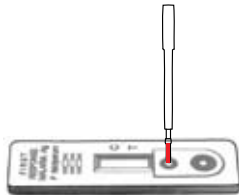

- 10.** Discard sample pipette in the Sharps box.



- 11.** Put two (2) drops of assay diluent into the large round hole.

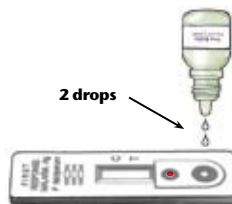

- 12.** Wait **20 minutes** after adding assay diluent.



- 13.** Read test results. (**NOTE: Do Not** read the test sooner than **20 minutes** after adding the assay diluent. You may get **FALSE** results.)

- 14.** How to read the test results:

POSITIVE

A line in "**C**" **AND** a line in "**T**" means the patient **DOES** have *falciparum* malaria.

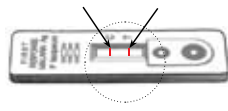

The test is **POSITIVE** even if the line in "**T**" is faint.

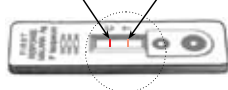

NEGATIVE

A line in "**C**" and **NO LINE** in "**T**" means the patient **DOES NOT** have *falciparum* malaria.



INVALID RESULT

NO LINE in "**C**" and a line or no line in "**T**" means the test is **INVALID**.

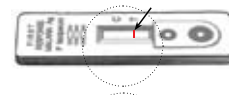

Repeat the test using a new RDT if no control line appears.

If no line appears in "**C**," repeat the test using a **NEW unopened** test packet and a **NEW unopened** lancet.

- 15.** Dispose of the gloves, alcohol swab, desiccant sachet and packaging in a non-sharps waste container.



- 16.** Record the test results in your CHW register. Dispose of cassette in non-sharps waste container.



NOTE: Each test can be used ONLY ONE TIME.
Do not try to use the test more than once.



Produced by the Foundation for Innovative New Diagnostics (FIND) from generic material developed jointly by the World Health Organization (WHO), United States Agency for International Development (USAID), University Research Co., LLC (URC), Special Programme for Research and Training in Tropical Diseases (STR), Malaria Consortium and Zambia National Malaria Control Centre.

Sample test #1

First Response Malaria HRP2 RDT Quiz 1

1



6



2



7



3



8



4



9



5



10



Sample test #2

First Response Malaria HRP2 RDT Quiz 2

1



6



2



7



3



8



4



9



5



10



Sample test #3

First Response Malaria HRP2 RDT Quiz 3

1



6



2



7



3



8



4



9



5



10



Answer keys for the sample tests

Sample test #1

First Response Malaria HRP2

	Positive (+)	Negative (-)	Invalid
1.		✓	
2.			✓
3.		✓	
4.	✓		
5.	✓		
6.			✓
7.		✓	
8.		✓	
9.	✓		
10.		✓	

Sample test #1

1. Negative
2. Invalid (No control)
3. Negative
4. Positive
5. Positive
6. Invalid
7. Negative
8. Negative
9. Positive
10. Negative

Sample test #2

First Response Malaria HRP2

	Positive (+)	Negative (-)	Invalid
1.	✓		
2.			✓
3.		✓	
4.		✓	
5.		✓	
6.		✓	
7.	✓		
8.		✓	
9.	✓		
10.		✓	

Sample test #2

1. Positive
2. Invalid (No control)
3. Negative
4. Negative
5. Negative
6. Negative
7. Positive
8. Negative
9. Positive
10. Negative

Sample test #3

First Response Malaria HRP2

	Positive (+)	Negative (-)	Invalid
1.	✓		
2.		✓	
3.			✓
4.		✓	
5.	✓		
6.		✓	
7.	✓		
8.		✓	
9.		✓	
10.		✓	

Sample test #3

1. Positive
2. Negative
3. Invalid (No control)
4. Negative
5. Positive
6. Negative
7. Positive
8. Negative
9. Negative
10. Negative

Suggested Answers (should be adjusted according to local treatment regimen)

Diagnosis (type of malaria)	Immediate Next Step Action	Continued management of case
Negative	Manage for other cause of fever (e.g. IMCI protocol). <i>If signs of severe malaria are present</i> treat for malaria and refer while excluding other illness	Review if not improved, repeat RDT once after 1–2 days if no other cause identified and symptoms of malaria continue ^a
Positive	Treat for falciparum malaria	Manage for falciparum malaria, refer if signs of severe malaria or if not improved
Invalid (no control line)	Repeat test	If further invalid result on repeat test — Manage for malaria based on symptoms, or refer for microscopy-based diagnosis — Replace RDT box and have RDT accuracy checked

^a Management of a negative test assumes that a quality assurance process is in place to ensure that RDTs are performing well. Well-functioning RDTs may still occasionally produce a false-negative if parasite density is low, or if variation in structure of production of parasite antigen reduces the ability of the RDT to detect the parasite. In *P. falciparum*-endemic areas, it is therefore recommended that health workers be allowed to treat for *P. falciparum* infection if symptoms of *severe malaria* are present, while investigating for other causes of illness and referring urgently for further management.

RDT Interpretation Chart

	Control line	Test line
<i>P. falciparum</i>-detecting RDT	e.g., detects HRP2 only	
Negative		
Positive ¹		
Invalid		
Invalid		

NOTE: ANY visible test line, **EVEN IF VERY FAINT**, indicates malaria (as long as a control line is also present).

Blank answer sheets for sample tests

NAME _____

DATE _____

TEST

	Positive (+)	Negative (-)	Invalid
1.			
2.			
3.			
4.			
5.			
6.			
7.			
8.			
9.			
10.			

TEST

	Positive (+)	Negative (-)	Invalid
1.			
2.			
3.			
4.			
5.			
6.			
7.			
8.			
9.			
10.			

TEST

	Positive (+)	Negative (-)	Invalid
1.			
2.			
3.			
4.			
5.			
6.			
7.			
8.			
9.			
10.			

TEST

	Positive (+)	Negative (-)	Invalid
1.			
2.			
3.			
4.			
5.			
6.			
7.			
8.			
9.			
10.			

